

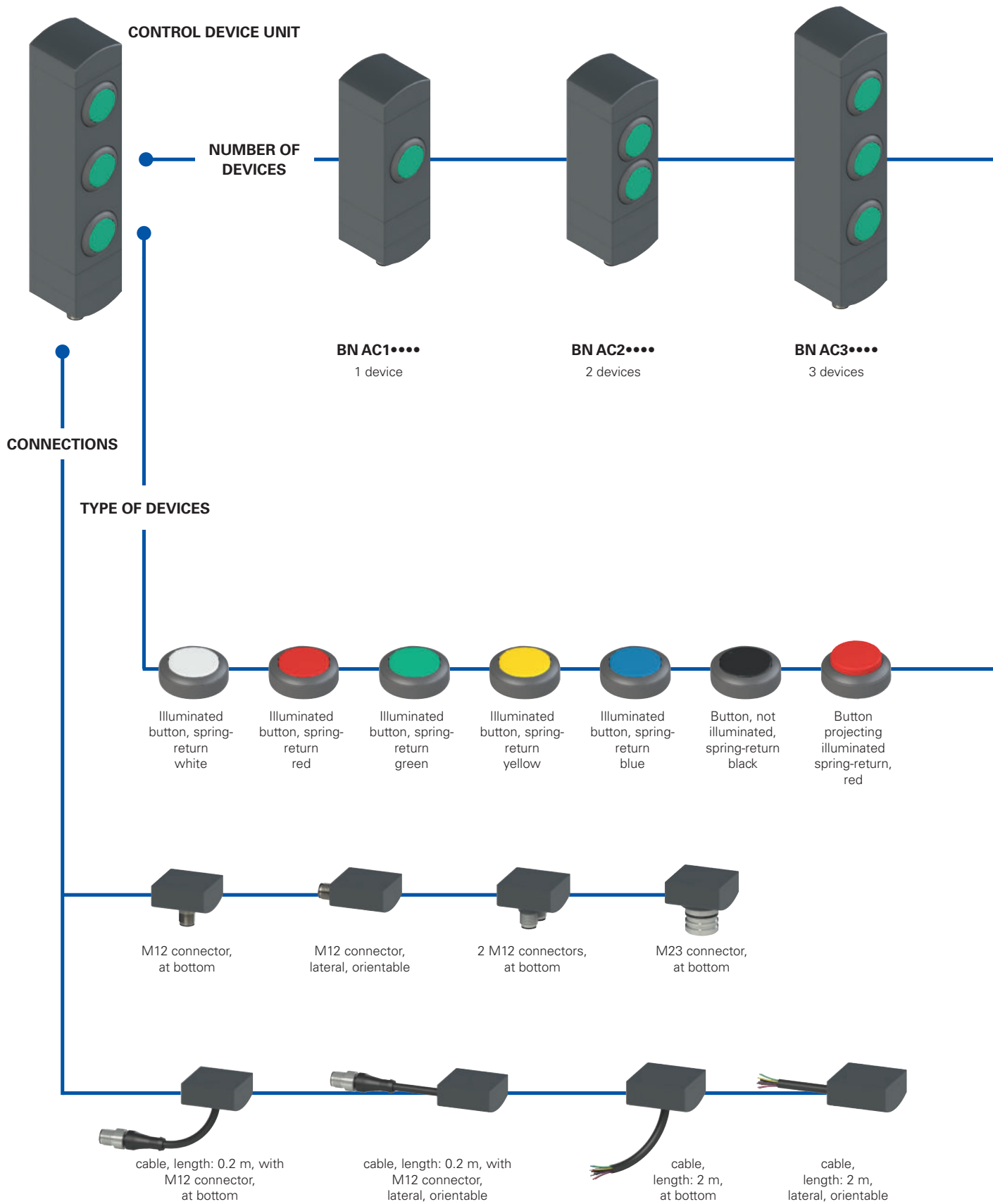

BN series control device units



Selection diagram



● product option
 → Sold separately as accessory

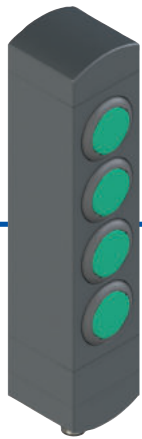

BN AC4••••
4 devices

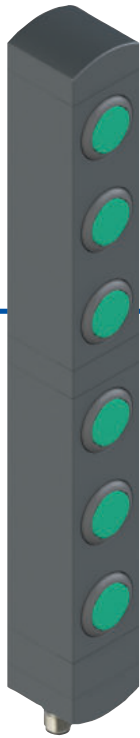

BN AC6••••
6 devices

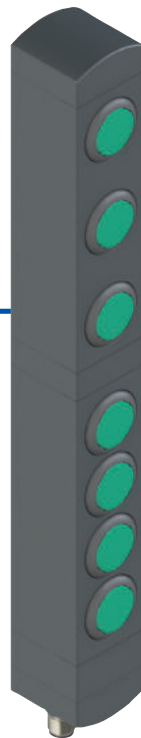

BN AC7••••
7 devices



BN AC8••••
8 devices

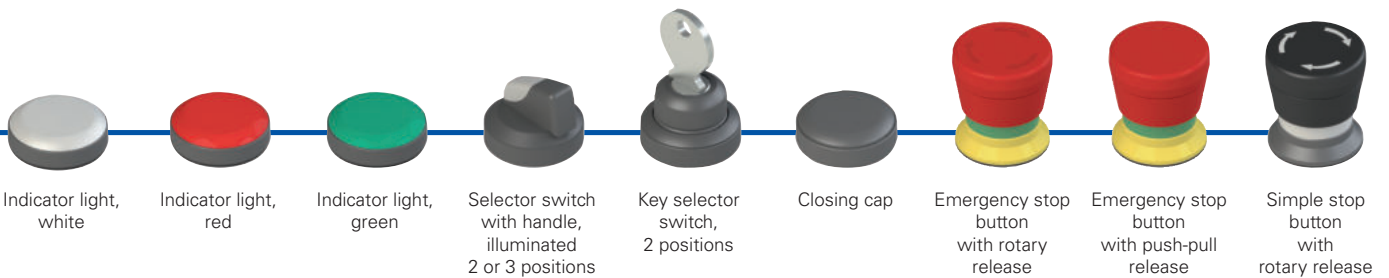

Indicator light, white

Indicator light, red

Indicator light, green

Selector switch with handle, illuminated 2 or 3 positions

Key selector switch, 2 positions

Closing cap

Emergency stop button with rotary release

Emergency stop button with push-pull release

Simple stop button with rotary release

Code structure

Attention! The feasibility of a code number does not mean the effective availability of a product. Please contact our sales office.

BN AC3ZA01

Number of devices	
1	1 device
2	2 devices
3	3 devices
4	4 devices
6	6 devices
7	7 devices
8	8 devices

Button configuration	
A01	A01 configuration
A02	A02 configuration
A03	A03 configuration
...	other configurations on request

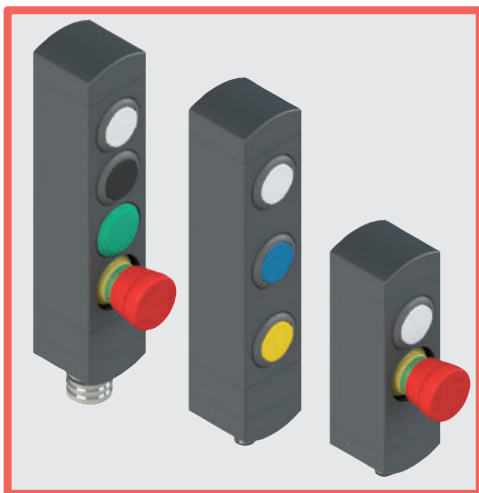

Main features

- Modular control device unit for 1 to 8 devices.
- Can be fixed in various positions.
- Flush-mounted control devices.
- Compact dimensions, minimal housing width.
- Numerous control devices available.

Quality marks:



UL approval: E131787

Features approved by UL

Electrical ratings: 24 Vdc Class 2, 0,1 A
 Input Supplied by 24V dc, Class 2 Source or limited voltage limited energy, 0,096 A max. (maximum eight leds).
 Output 24 Vac/dc Class 2 0,25 A Pilot Duty (maximum eight actuators, with maximum twelve contacts, NO or NC or both) or 0,18 A Pilot Duty (maximum eight actuators, with maximum sixteen contacts, NO or NC or both).
 Environmental ratings: Type 1

Technical data

Housing made of glass fibre reinforced technopolymer, self-extinguishing and shock-proof.
 Versions with integrated cable 12 x 0.14 mm², length 2 m, other lengths from 0.5 m to 10 m on request.

Versions with integrated M23 or M12 stainless steel connector.

Versions with 2 integrated M12 stainless steel connectors.

Versions with 0.2 m cable and M12 connector, other lengths from 0.1 ... 3 m on request.

Protection degree: IP65 acc. to EN 60529

General data

Ambient temperature:	-25°C ... +70°C	
Fixing screws for the housing:	2xM5, tightening torque 3 Nm	
Fixing screws for turnable modules:	Tightening torque of 0.8 ... 1.2 Nm	
Mechanical endurance:		
Spring-return button:	1 million operating cycles	
Emergency stop button:	50,000 operating cycles	
Selector switch:	300,000 operating cycles	
Key selector switch:	50,000 operating cycles	
	30,000 operating cycles including removal of the key	

Safety parameter B_{10D} : 100,000 (emergency stop button)

Actuating force:		
Spring-return button:	4 N min	100 N max.
Emergency stop button:	20 N min	100 N max.
Selector switch:	0.1 Nm min	1.5 Nm max.
Key selector switch:	0.1 Nm min	1.3 Nm max.

Electrical data of the devices

Rated operating voltage U_e :	24 Vdc \pm 10% SELV	
Thermal current I_{th} :	1 A	
Rated insulation voltage U_i :	32 Vac/dc	
Rated impulse withstand voltage U_{imp} :	1.5 kV	
Material of the contacts:	silver contacts	
Contact type:	Self-cleaning contacts with double interruption	
Utilization category of the contact block:	DC-13; $U_e = 24$ V, $I_e = 0.55$ A	
LED supply voltage:	24 Vdc \pm 15%	
Single LED supply current:	12 mA	

M12 connector electrical data

Max. operating voltage:	32 Vac/dc
Max. operating current:	1.5 A max.

M23 connector electrical data

Max. operating voltage:	32 Vac/dc
Max. operating current:	3 A max.

In compliance with standards:

IEC 60947-5-1, IEC 60947-5-5, EN ISO 13850, UL 508, CSA 22.2 No.14

Compliance with the requirements of:

Machinery Directive 2006/42/EC, Low Voltage Directive 2014/35/EU, EMC Directive 2014/30/EU, RoHS Directive 2011/65/EU.

⚠ Installation for safety applications:

Always connect the safety circuit to the **NC contacts** (normally closed contacts) as stated in standard EN 60947-5-1.

Actuation of the control devices from various directions

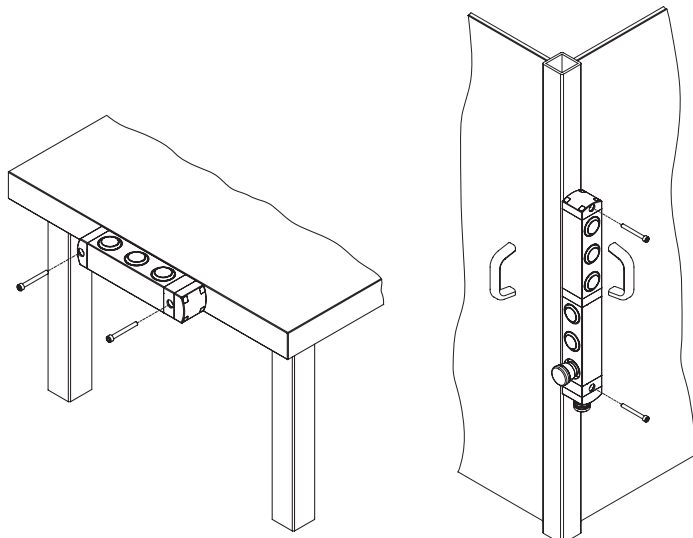

Thanks to the design with turnable modules, the control device units of the BN series offer the user many different options for fixing to the machine.

The orientation of the control devices can be selected independent of the fastening.

With the configurations for 6, 7 and 8 devices, the upper and lower part can be oriented independent of one another. This is especially useful if it should be possible to achieve a command state from two different sides of the machine. In these cases, a single device and single wiring harness can be used, thereby saving time and money.



General data



The new modular control device units of the BN series from Pizzato Elettrica can be combined perfectly with the RFID safety switches with lock of the NS series. Machine manufacturers who already use these products thereby have the possibility to attach a control device unit directly next to the safety switch that is identical in shape and dimensions.

The control device units of the BN series are available in configurations with 1 to 8 devices.

The unique design with individually turnable modules allows the user to select from a number of combinations. He receives a very versatile product that is immediately ready for use.

Compatibility with NS series switches

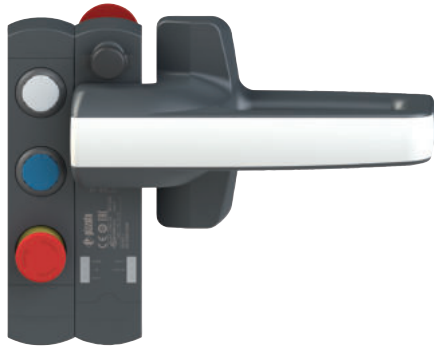

The control device units of the BN series have the same dimensions as the RFID safety switches with lock of the NS series. When mounted directly to the side of the switch, one obtains an integrated safety device whose components are made of the same material and have identical dimensions.

Minimal dimensions



One special feature of the control device units of the BN series is the slim thickness of just 40 mm.

The control devices are embedded in the housing of the unit and protrude only slightly out of the front.

This protects the control devices from unintended impacts, thereby increasing the service life of the devices and, at the same time, giving the devices an attractive design, making them predestined for use on modern machines in which this aspect is also given special consideration.

Turnable and non-detachable modules

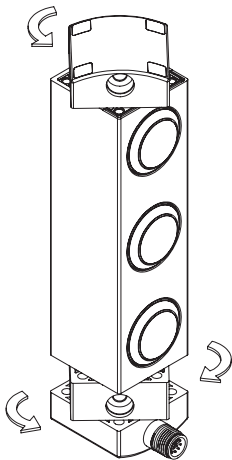

During installation, the fixing modules can be turned on the top and bottom of the device to enable variable orientation of the control devices.

Operation is very simple: after loosening the fixing screws, the device body can be turned in steps of 90° and fixed in the desired position. Another advantage for the installer is that the fixing modules cannot be detached from the device body. Disassembly of the individual parts is not necessary and there is no risk of losing parts or reassembling incorrectly.

Protection against tampering

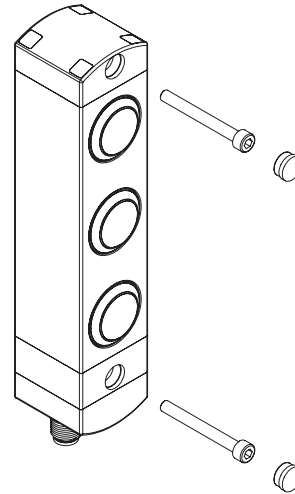

Each control device unit of the BN series is supplied complete with snap-on protection caps to be applied on the holes of the fixing screws. Not only do the caps prevent deposits of dirt from accumulating and simplify cleaning, they also prevent access to the fixing screws of the device, thereby offering increased protection against tampering.

Individually and freely configurable

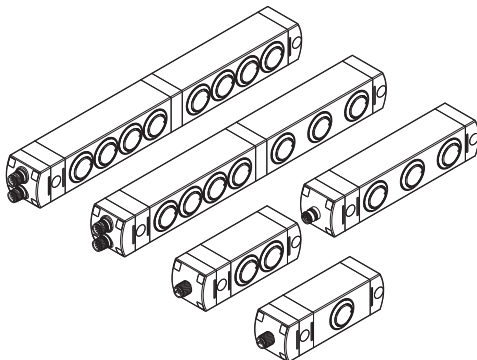

The control device unit is available in various configurations: for standard applications there are configurations with 1 to 4 devices, while configurations with 6, 7 or 8 devices are available for more complex applications that allow a larger number of control and signalling devices to be attached at the same location for the user.

New laser markable lenses



With all product configurations, a number of devices can be installed that can also be illuminated via LEDs integrated in the device.

The buttons have new lenses that can be marked by laser for a resistant, indelible engraving. This allows you to customize the lenses with a wide range of text and symbols. For a complete list of available engravings, please refer to the tables on pp. 14-17.

Examples of available configurations

BN AC1ZA01

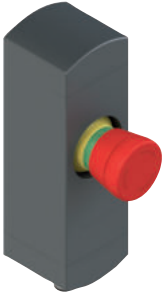

	Description	Colour	Diagram
Device 1	Emergency stop button with rotary release 2NC	red	
Connector	M12, 5-pole at bottom	/	

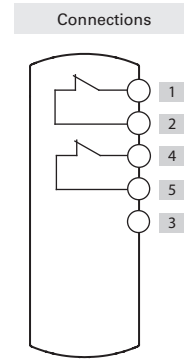

BN AC1ZA02



	Description	Colour	Diagram
Device 1	Illuminated button, spring-return 1NO	white	
Connector	M12, 5-pole, at bottom	/	

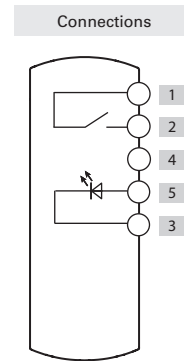

BN AC1ZA03



	Description	Colour	Diagram
Device 1	Illuminated selector switch with handle with two positions 1NO	black	
Connector	M12, 5-pole, at bottom	/	

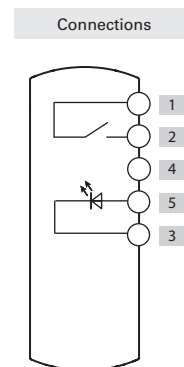



BN AC2ZA01

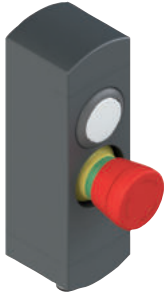

	Description	Colour	Diagram
Device 1	Illuminated button, spring-return 1NO	white	
Device 2	Emergency stop button with rotary release 2NC	red	
Connector	M12, 8-pole, at bottom	/	

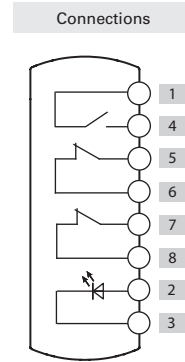

BN AC2ZA02

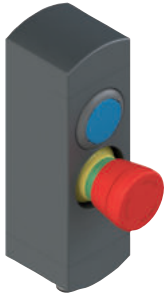

	Description	Colour	Diagram
Device 1	Illuminated button, spring-return 1NO	blue	
Device 2	Emergency stop button with rotary release 2NC	red	
Connector	M12, 8-pole, at bottom	/	

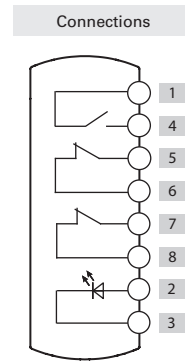

BN AC2ZA03



	Description	Colour	Diagram
Device 1	Illuminated button, spring-return 1NO	white	
Device 2	Illuminated button, spring-return 1NO	blue	
Connector	M12, 8-pole, at bottom	/	

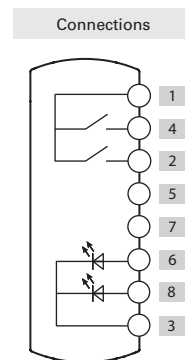

BN series control device units

BN AC3ZA01



	Description	Colour	Diagram
Device 1	Illuminated button, spring-return 1NO	white	
Device 2	Illuminated button, spring-return 1NO	blue	
Device 3	Illuminated button, spring-return 1NO	yellow	
Connector	M12, 12-pole, at bottom	/	

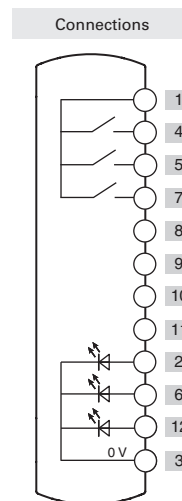

BN AC3ZA02



	Description	Colour	Diagram
Device 1	Illuminated button, spring-return 1NO	white	
Device 2	Illuminated button, spring-return 1NO	blue	
Device 3	Emergency stop button with rotary release 2NC	red	
Connector	M12, 12-pole, at bottom	/	

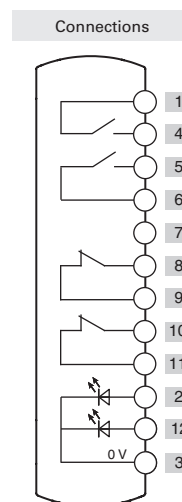

BN AC3ZA03



	Description	Colour	Diagram
Device 1	Illuminated button, spring-return 1NO	white	
Device 2	Illuminated button, spring-return 1NO	yellow	
Device 3	Emergency stop button with rotary release 2NC	red	
Connector	M12, 12-pole, at bottom	/	

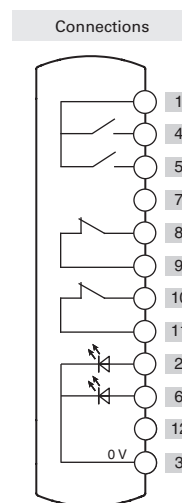



BN AC4ZA01

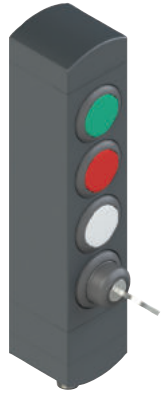

	Description	Colour	Diagram
Device 1	Illuminated button, spring-return 1NO	green	
Device 2	Illuminated button, spring-return 1NO	red	
Device 3	Illuminated button, spring-return 1NO	white	
Device 4	Two-position key selector switch 1NO	black	
Connector	M12, 12-pole, at bottom	/	

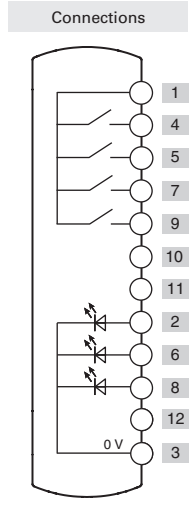

BN AC4ZA02

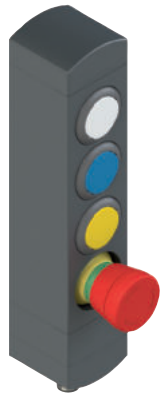

	Description	Colour	Diagram
Device 1	Illuminated button, spring-return 1NO	white	
Device 2	Illuminated button, spring-return 1NO	blue	
Device 3	Illuminated button, spring-return 1NO	yellow	
Device 4	Emergency stop button with rotary release 2NC	red	
Connector	M12, 12-pole, at bottom	/	

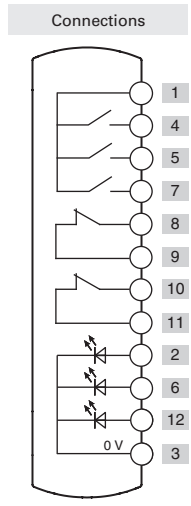

BN AC4ZA03



	Description	Colour	Diagram
Device 1	Illuminated button, spring-return 1NO	white	
Device 2	Spring-return button 1NO	black	
Device 3	Indicator light	green	
Device 4	Emergency stop button with rotary release 2NC	red	
Connector	M23, 12-pole, at bottom	/	

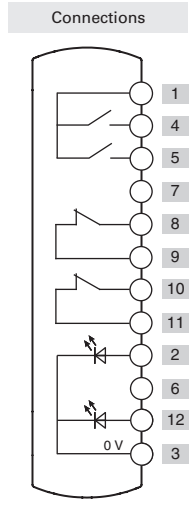

For pin assignments of the connectors, see page 13

BN series control device units

BN AC6ZA01



	Description	Colour	Diagram
Device 1	Illuminated button, spring-return 1NO	white	
Device 2	Illuminated button, spring-return 1NO	blue	
Device 3	Illuminated button, spring-return 1NO	yellow	
Device 4	Indicator light	green	
Device 5	Indicator light	white	
Device 6	Emergency stop button with rotary release 2NC	red	
Connector	Two M12, 12-pole, at bottom	/	

Connections

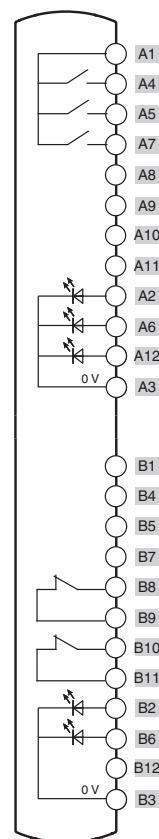

BN AC6ZA02



	Description	Colour	Diagram
Device 1	Illuminated button, spring-return 1NO	white	
Device 2	Illuminated button, spring-return 1NO	blue	
Device 3	Illuminated button, spring-return 1NO	yellow	
Device 4	Indicator light	green	
Device 5	Indicator light	white	
Device 6	Emergency stop button with rotary release 2NC	red	
Connector	M23, 19-pole, at bottom	/	

Connections

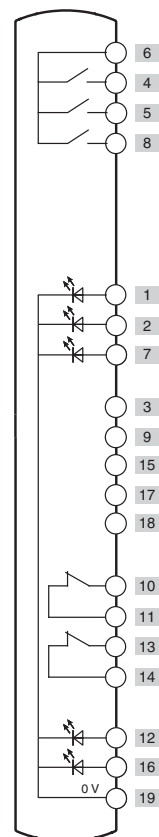



BN AC7ZA01

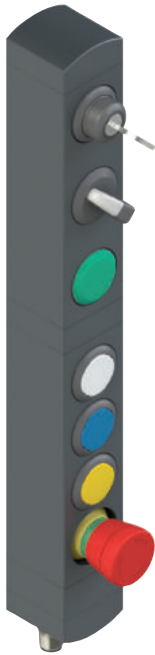

	Description	Colour	Diagram
Device 1	Two-position key selector switch 1NO	black	
Device 2	Illuminated selector switch with handle with two positions 1NO	black	
Device 3	Indicator light	green	
Device 4	Illuminated button, spring-return 1NO	white	
Device 5	Illuminated button, spring-return 1NO	blue	
Device 6	Illuminated button, spring-return 1NO	yellow	
Device 7	Emergency stop button with rotary release 2NC	red	
Connector	Two M12, 12-pole, at bottom	/	

Connections

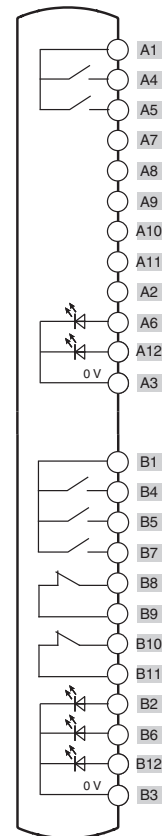

BN AC8ZA01



	Description	Colour	Diagram
Device 1	Illuminated selector switch with handle with two positions 1NO	black	
Device 2	Indicator light	red	
Device 3	Indicator light	green	
Device 4	Illuminated button, spring-return 1NO	yellow	
Device 5	Illuminated button, spring-return 1NO	white	
Device 6	Spring-return button 1NO	black	
Device 7	Illuminated button, spring-return 1NO	blue	
Device 8	Emergency stop button with rotary release 2NC	red	
Connector	Two M12, 12-pole, at bottom	/	

Connections

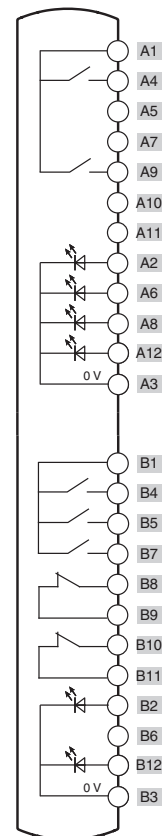

For pin assignments of the connectors, see page 13

Available integrated devices

	Description	Colour	Article	Combinable with contacts ⁽¹⁾	Protrusion (x) mm
	Illuminated button, spring-return	<ul style="list-style-type: none"> ● White ● Red ● Green ● Yellow ● Blue 	VN NG-AC27121 VN NG-AC27123 VN NG-AC27124 VN NG-AC27125 VN NG-AC27126	1NO (1NC) (2NO) (1NO+1NC)	3
	Non-illuminated button, spring-return	● Black	VN NG-AC27122	1NO (1NC) (2NO) (1NO+1NC)	3
	Non-laser-markable, illuminated, projecting push button ⁽²⁾	● Red	VN NG-AC26018	1NO (1NC) (2NO) (1NO+1NC)	6.1
	Indicator light	<ul style="list-style-type: none"> ● Red ● Yellow ● Green ● Blue ● White 	VN NG-AC26060 VN NG-AC26061 VN NG-AC26062 VN NG-AC26063 VN NG-AC26064	/	2.7
	Emergency stop button acc. to EN ISO 13850				
	Rotary release Push-pull release	<ul style="list-style-type: none"> ● Red ● Red 	VN NG-AC26052 VN NG-AC26055	2NC	26.4
	Emergency stop button for contact blocks with 3 contacts acc. to EN ISO 13850				
	Rotary release	● Red	VN NG-AC26056	2NC+1NO	26.4
	Illuminated emergency stop button acc. to EN ISO 13850				
	Rotary release Push-pull release	<ul style="list-style-type: none"> ● Red ● Red 	VN NG-AC26051 VN NG-AC26054	2NC	26.4
	Simple stop button				
	Rotary release Push-pull release	<ul style="list-style-type: none"> ● Black ● Black 	VN NG-AC26053 VN NG-AC26057	2NC	26.4
	Illuminated selector switch with handle, with transparent lens for LED				
	<ul style="list-style-type: none"> ✓ ▷ ▽ ◁▷ 	<ul style="list-style-type: none"> ● Black ● Black ● Black ● Black 	VN NG-AC26033 VN NG-AC26030 VN NG-AC26034 VN NG-AC26031	1NO 1NC (2NO) (1NO+1NC)	16.8
	Key selector switch, 2 positions				
	<ul style="list-style-type: none"> ⌘ ▷ ◁▷ 	<ul style="list-style-type: none"> ● Black ● Black ● Black 	VN NG-AC26043 VN NG-AC26040 VN NG-AC26041	1NO (1NC) (2NO) (1NO+1NC)	39 (a) 14 (b)
	Closing cap	● Black	VN NG-AC26020	/	2.7
	Fixing key	● Black	VN NG-AC26080	/	/

Legend: ✓ Maintained ▷ Spring-return ⌘ Key extraction position (a) with key (b) without key

⁽¹⁾ The contacts in brackets are on request. Contact our technical department to verify the effective feasibility of the control panel with the chosen combination of control devices.

⁽²⁾ The projecting buttons are not laser markable.

To order buttons with marking:

add the marking code indicated in the tables on pp. 14-17 to the article codes.

Example: Black spring-return button with "O" engraving.

VN NG-AC27122 → VN NG-AC27122-L1



Dimensional drawings

BN AC1●●●●

BN AC2●●●●

BN AC3●●●●

BN AC4●●●●

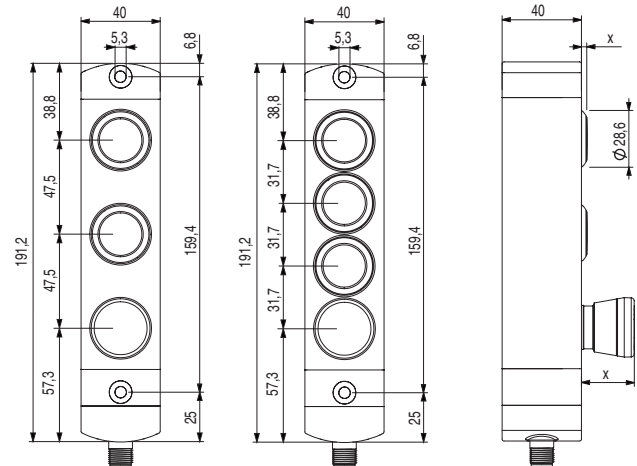
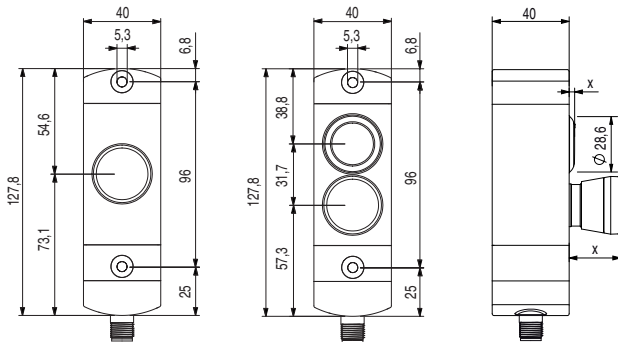

BN AC6●●●●

BN AC7●●●●

BN AC8●●●●

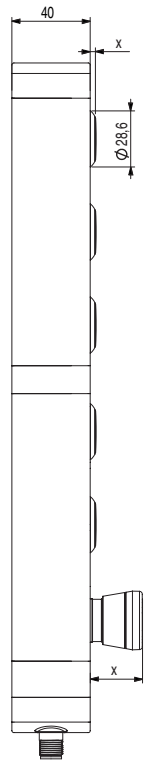
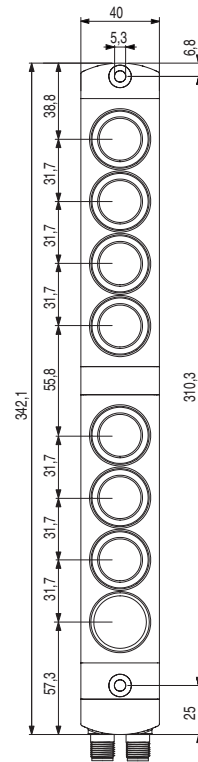
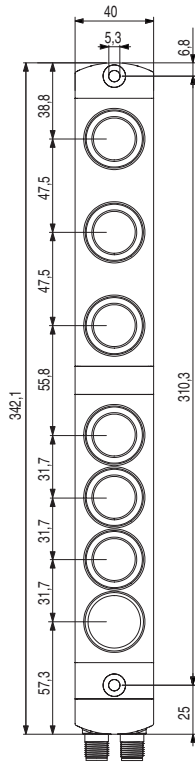
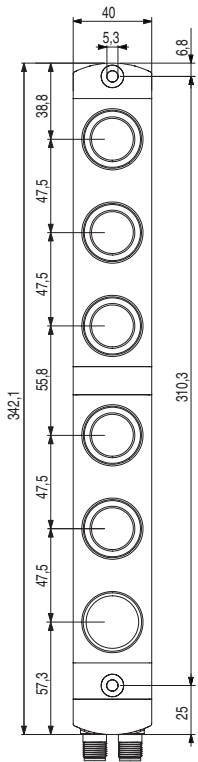

Output type

M12 connector, at bottom

M12 connector, lateral

Two M12 connectors, at bottom

M23 connector, at bottom

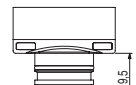
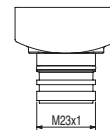
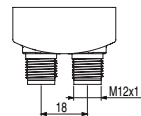
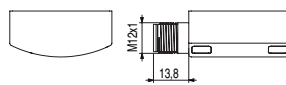
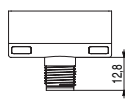
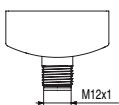

All values in the drawings are in mm

→ The 2D and 3D files are available at www.pizzato.com

Electrical connections

M12 connector, 5-pole

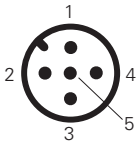

M12 connector, 8-pole

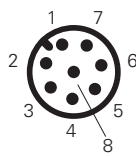

Cable

Pin No.	Cable colour	Pin No.	Cable colour
1	brown	7	black
2	blue	8	grey
3	white	9	red
4	green	10	purple
5	pink	11	grey-pink
6	yellow	12	red-blue

M12 connector, 12-pole

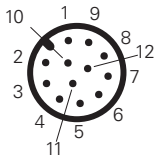

Two M12 connectors, 12-pole

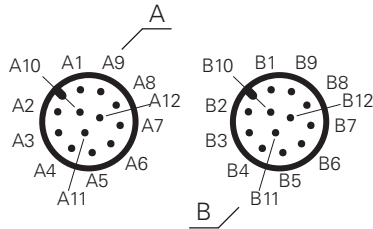

M23 connector, 12-pole

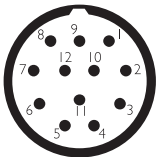

M23 connector, 19-pole

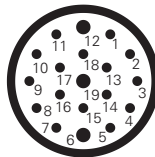



List of available engravings

Code	Symbol	Code	Symbol	Code	Symbol	Code	Symbol	Code	Symbol	Code	Symbol
L1		L42		L27		L330		L187		L386	
L287		L43		L147		L455		L230		L395	
L413		L213		L148		L456		L249		L411	
L2		L254		L162		L369		L376		L414	
L3		L17		L172		L426		L102		L415	
L4		L44		L220		L59		L103		L418	
L35		L45		L277		L64		L139		L419	
L36		L46		L226		L62		L140		L420	
L37		L60		L142		L63		L141		L80	
L11		L191		L54		L86		L157		L374	
L12		L193		L56		L88		L381		L476	
L412		L308		L57		L89		L445		L472	
L188		L61		L55		L87		L278		L473	
L14		L153		L146		L76		L323		L474	
L32		L194		L293		L77		L362		L475	
L33		L309		L304		L78		L380			
L34		L408		L305		L190		L382			
L240		L145		L470		L416		L383			
L16		L336		L317		L417		L384			
L41		L96		L319		L189		L385			

Other engravings on request

BN series control device units

Code	Symbol	Code	Symbol	Code	Symbol	Code	Symbol	Code	Symbol	Code	Symbol
L7		L25		L84		L174		L316		L441	
L8		L30		L90		L175		L394		L295	
L9		L31		L91		L176		L399			
L10		L58		L312		L294		L436			
L18		L75		L311		L313		L437			
L143		L425		L442		L314		L438			
L24		L454		L443		L227		L439			
L310		L83		L170		L228		L440			
L234		L241		L247		L279		L392		L467	
L235		L242		L248		L280		L393		L468	
L236		L243		L251		L375		L463			
L237		L244		L252		L389		L464			
L238		L245		L253		L390		L465			
L239		L246		L260		L391		L466			

Other engravings on request



Code	Symbol	Code	Symbol	Code	Symbol	Code	Symbol	Code	Symbol	Code	Symbol
L28	STOP	L67	3	L39	R	L289	BOOST	L208	X+	L135	AVANTI - INDIETRO
L50	STOP	L68	4	L114	RESET	L292	MONO / TRI	L117	POMPA FILTRO 0 - 1	L104	24V 电源指示 24V Power
L48	STOP	L69	5	L306	RESET	L327	ENABLE DISABLE	L118	FILTER PUMP 0 - 1	L105	220V 电源指示 220V Power
L49	STOP	L70	6	L130	100%	L222	ACCESS DENIED	L119	RISCALDAMENTO 0 - 1	L106	选择开关 Selector
L113	STOP	L71	7	L315	24V=	L223	ACCESS ALLOWED	L120	HEATING 0 - 1	L107	启动按钮 START
L29	START	L72	8	L82	EROUND	L224	ACCESS REQUEST	L121	SCATTO TERMICO	L108	停止按钮 STOP
L53	START	L73	9	L199	SPEED	L225	ACCESS RESET	L122	CIRCUIT BREAKER	L109	电源指示 Power
L51	START	L74	0	L233	CAUTION	L215	INIT	L123	MAN. - AUT.	L110	合闸指示 Ready
L52	START	L450	-1	L250	POWER	L216	C / C	L124	START CICLO	L111	故障指示 Stoppage
L218	START	L451	-2	L332	ALLOW IN	L370	UNLOCK DOOR	L125	RADDRIZZATORE 0 - 1		
L276	START STOP	L129	3/4	L334	SYSTEM START	L371	REQUEST / RESET ACCESS TO AREA	L126	STOP CICLO		
L410	PAUSE (START)	L15	R	L335	SYSTEM STOP	L205	Y+	L127	BY-PASS EMERGENZE 0 - 1		
L65	1	L40	R	L333	CYCLE STOP	L206	X-	L131	AZIONAMENTO 0 - 1		
L66	2	L38	R	L281	DEFAULT	L207	-Y	L132	TACITAZIONE SIRENA		

Other engravings on request

List of available engravings – TEXTS

Code	Text	Code	Text	Code	Text	Code	Text
IT0	ARRESTO	GB0	STOP	FR0	ARRÊT	DE0	HALT
IT1	AVVIO	GB1	START	FR1	MARCHE	DE1	START
IT2	CHIUSO	GB2	CLOSE	FR2	FERMÉ	DE2	ZU
IT3	SU	GB3	UP	FR3	MONTÉE	DE3	AUF
IT4	GIÚ	GB4	DOWN	FR4	DESCENTE	DE4	AB
IT5	SPENTO	GB5	OFF	FR5	ARRÊT	DE5	AUS
IT6	ACCESO	GB6	ON	FR6	MARCHE	DE6	EIN
IT7	IN SERVIZIO	GB7	RUN	FR7	EN SERVICE	DE7	BETRIEB
IT8	ERRORE	GB8	FAULT	FR8	PANNE	DE8	STÖRUNG
IT9	TEST	GB9	TEST	FR9	ESSAI	DE9	PRÜFUNG
IT10	SPENTO ACCESO	GB10	OFF ON	FR10	ARRÊT MARCHE	DE10	AUS EIN
IT11	MAN. AUTO	GB11	MAN. AUTO	FR11	MAN. AUTO	DE11	HAND AUTO
IT12	MAN. 0 AUTO	GB12	MAN. 0 AUTO	FR12	MAN. 0 AUTO	DE12	HAND 0 AUTO
IT13	MARCIA	GB13	DRIVE	FR13	MARCHE	DE13	ANTRIEB
IT14	RIAVVIA	GB14	RESET	FR14	REARM.	DE14	ENTSPERREN
IT15	AVANTI	GB15	FORWARD	FR15	AVANT	DE15	VORWÄRTS
IT16	INDIETRO	GB16	REVERSE	FR16	ARRIÈRE	DE16	RÜCKWÄRTS
IT17	AUMENTA	GB17	RAISE	FR17	MONTER	DE17	HEBEN
IT18	DIMINUISCI	GB18	LOWER	FR18	DESCENDRE	DE18	SENKEN
IT19	SINISTRA	GB19	LEFT	FR19	GAUCHE	DE19	LINKS
IT20	DESTRA	GB20	RIGHT	FR20	DROITE	DE20	RECHTS
IT21	FRENO	GB21	BRAKE	FR21	FERMER/OUVRIR	DE21	BREMSEN
IT22	ALTO	GB22	HIGH	FR22	HAUT	DE22	HOCH
IT23	BASSO	GB23	LOW	FR23	BAS	DE23	NIEDRIG
IT24	VELOCE	GB24	FAST	FR24	RAPIDE	DE24	SCHNELL
IT25	LENTO	GB25	SLOW	FR25	LENT	DE25	LANGSAM
IT26	PIÚ VELOCE	GB26	FASTER	FR26	PLUS RAPIDE	DE26	SCHNELLER
IT27	PIÚ LENTO	GB27	SLOWER	FR27	PLUS LENT	DE27	LANGSAMER
IT32	APRIRE	GB32	OPEN	FR32	OUVRIR	DE32	ÖFFNEN
IT63	CHIAMATA	GB63	CALL	FR63	APPEL	DE63	ANRUF
IT64	OCCUPATO	GB64	OCCUPIED	FR64	OCCUPÉ	DE64	BESETZT
IT99	ARRESTO D'EMERGENZA	GB99	EMERGENCY STOP	FR99	ARRÊT D'URGENCE	DE99	NOT-AUS

Other engravings on request



General Catalogue
Detection



General Catalogue
HMI



General Catalogue
Safety



General Catalogue
Lift



Website
www.pizzato.com



Pizzato Elettrica s.r.l. via Torino, 1 - 36063 Marostica (VI) Italy
Phone: +39 0424 470 930
E-mail: info@pizzato.com
Website: www.pizzato.com

Any information or application example, connection diagrams included, described in this document are to be intended as purely descriptive. The choice and application of the products in conformity with the standards, in order to avoid damage to persons or goods, is the user's responsibility. The drawings and data contained in this document are not binding and we reserve the right, in order to improve the quality of our products, to modify them at any time without prior notice. All rights to the contents of this publication are reserved in accordance with current legislation on the protection of intellectual property. The reproduction, publication, distribution and modification, total or partial, of all or part of the original material contained therein (including, but not limited to, texts, images, graphics), whether on paper or in electronic form, are expressly prohibited without written permission from Pizzato Elettrica Srl. All rights reserved. © 2021 Copyright Pizzato Elettrica.

ZE FGL28A21-ENG

